

Product Information Packet

Model AHP-301FF

120/240 VAC Solid State Air Conditioner

With TC-6F Temperature Control

Part #0-7081-0-000

Thank you for your purchase. Information has been enclosed regarding the installation, specifications, and wiring of your solid-state assembly. Please read and follow all instructions carefully before installation. Only qualified technicians should install this equipment.

If you have any questions regarding your equipment, please do not hesitate to call us at 773-342-4900, and we will be happy to assist you. We are open from 8:30 am-5:00 pm Central Time.

Included in this packet you will find:

Product Literature and Specifications

Assembly Drawing # 301-B-A51

Wiring Drawing # 301-B-E35

Installation Drawing # 301-B-F1

Temperature Control Information

Warranty Information

The logo for Teca, featuring the word "teca" in a bold, lowercase, sans-serif font. A vertical line is positioned to the left of the text, and a small diamond-shaped graphic is located at the bottom left corner of the logo area.

ThermoElectric Cooling America Corporation
4048 W. Schubert Avenue • Chicago, IL (U.S.A.) 60639
Ph: 773/342-4900 Fx: 773/342-0191
sales@thermoelectric.com www.thermoelectric.com

Important Installation Notes for Air

Mounting Styles: Both 'thru mount' and 'flush mount' units can be positioned in any orientation and on any enclosure surface. It is important to consider interior air flow patterns when determining the mounting location. Also of importance is an unrestricted flow of ambient air thru the hot side heat exchanger. Ease of access and inspection must be considered for those applications in particularly severe environments which may require occasional maintenance.

Vertical (Side/Front/Back) Mounting:

Vertical mounting refers to the vertical direction of the cold side or interior fins and is recommended for applications with high humidity, poor and incomplete cabinet seals or any condition which may cause the cold side fins to be maintained at temperatures below the dew point for long periods of time allowing for the formation of condensation. The vertical fin direction provides a drip path whereupon condensation can be collected via a moisture removal system (standard on FHP-units) or a drip pan positioned below the cold side fins. Drip pans are optional for thru mount units.

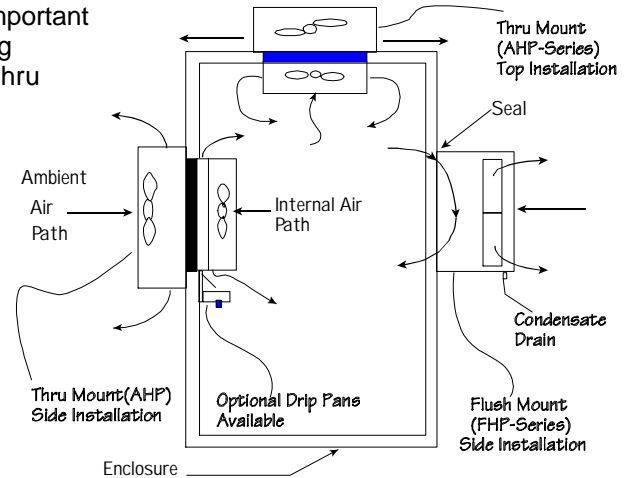

Condensate Removal System:

All FHP-Series and AHP-1400 air conditioners contain a built-in condensate removal system. The condensate kit consists of a antifungal sponge with a condensate wick. PVC tubing is also provided for drainage. Drip pans are optional for thru mount units which must be evaluated on an individual basis. Equations defining a relationship between the cold side fin and enclosure temperatures are provided to assist in the evaluation.

Top Mounting:

Though often the easiest location to mount it is often the most difficult to protect from condensation in this orientation due to the fin orientation, gravity and any susceptible components below. If a drip pan is employed by the end user use caution to place the pan far enough away from the internal fan to minimize the restriction of air flow. The pan should cover the fin ends as well as the fan area. When there is a choice, the vertical orientation is preferred by most users.

Maintenance:

Since the technology is solid-state, there are no filters, compressors, or fluorocarbons to maintain. The only moving parts are the fans. It is recommended for harsh or dirty environments that the heat sinks be cleaned from time to time. This can be accomplished by directing compressed air over the external fins or on NEMA 4 versions by hosing the unit down. This will increase the overall life and performance of the system.

Cautions:

Take care when mounting not to damage the seal between the hot and cold side sinks. Do not attempt to mount a unit to a warped surface or try to make the units mounting surface conform to an unflat surface. Do not pinch or damage any leads when mounting. Do not over tighten any installation screw, use reasonable force. Always mount with any condensate drain down. Do not compress the cold side between the hot side and any other surface. Do not obstruct the airflow on either side. When mounting consider the natural air flows of the enclosure. Connect power only after the installation is complete.

Notes on condensation:

Condensation occurs at the cold side fins when the surface temperature goes below the dew point. To reduce or remove condensate, consider the following:

- Regulate the Fin Temperature above the Dewpoint.
- Keep Enclosure Closed and Sealed from Outside Humidity.
- Use Desiccant (Moisture absorbing Granules.)
- Employ Condensate Removal System/Drip Pans.

If you have any questions regarding your installation, Please feel free to contact our technical department for assistance at 773-342-4900.

AHP-301FF Solid-State Air Conditioner

Air Cooled
Thru Mount
Nema-12

FEATURES

- Compact (only 10" L X 5.52" W X 7.83" D)
- Weighs only 12 lbs. (5.4 kg)
- Ambient range -10°C to +70°C
- Mounts and operates in any orientation: horizontal, vertical, etc.
- Low vibration and noise
- No moving parts except fans
- Environmentally safe
- Dual voltage
- No compressor, fluorocarbons or filters
- Virtually maintenance-free operation
- Stainless steel exterior housing

INCLUDES

- Integral power supply 120/240 VAC
- Gasket and mounting hardware

APPLICATIONS

Cools electronic enclosures and control cabinets in factories and elsewhere.



SPECIFICATIONS

MODEL	PART NUMBER	NOTES	PERFORMANCE RATING BTU/HR	VOLTAGE VAC 50/60HZ	CURRENT AMPS.	WEIGHT LBS.(KG)	TEMP. CONTROL *	OPERATING AMBIENT °C
AHP-301FF	0-7091-0-000	Cool only	160-200	120/240	1.4/1.70	12(5.4)	none	-10/+70
AHP-301FF	0-7081-0-000	Cool only	160-200	120/240	1.4/1.70	12(5.4)	TC-6F	-10/+70
AHP-301FFHC	0-7031-1-000	Heat/Cool	160-200	120/240	1.4/1.70	12(5.4)	TC-3F	-10/+70
AHP-301FF	0-7051-0-000	Cool only	160-200	120/240	1.4/1.70	12(5.4)	OPT*	-10/+70
AHP-301FFHC	0-7051-1-000	Heat/Cool	160-200	120/240	1.4/1.70	12(5.4)	OPT*	-10/+70
AHP-301FF/85	0-70F1-0-000	Cool only	160-200	120/240	1.4/1.70	12(5.4)	85°F (30°C)	-10/+70
AHP-301FF/3300	0-70D1-0-000	Cool only	160-200	120/240	1.4/1.70	14(6.4)	TC-3300	-10/+70
AHP-301FFHC/3300	0-70D1-1-000	Heat/Cool	160-200	120/240	1.4/1.70	14(6.4)	TC-3300	-10/+70

*OPT; Unit is set up for TC-3300 Controller (or similar)

AHP-301FF

PERFORMANCE CURVE

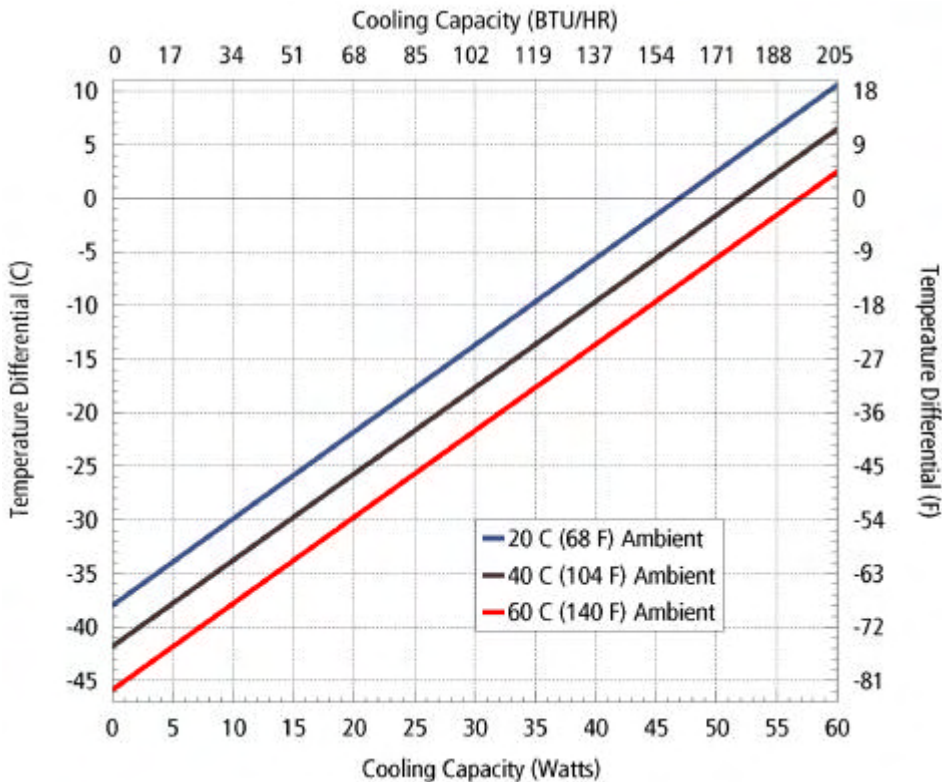

Equation of line: $y = \Delta T(^{\circ}C)$ $x = \text{Capacity (Watts)}$			
Ambient Temp	20°C	40°C	60°C
Enclosure Air	$y = .81x - 38.0$	$y = .81x - 42.0$	$y = .81x - 46.0$
Cold Sink	$y = .62x - 38.0$	$y = .62x - 42.0$	$y = .62x - 46.0$

MOUNTING STYLE

Thru Mount

ENVIRONMENTS

Nema-12 IP 40 (maintains IP 52)

RATING (TRADITIONAL)

180 BTU/hr @ 0 °F ΔT

220 BTU/hr @ +20 °F ΔT *

RATING (DIN 3168)

52 Watts L35 L35

36 Watts L35 L50

* See page 6

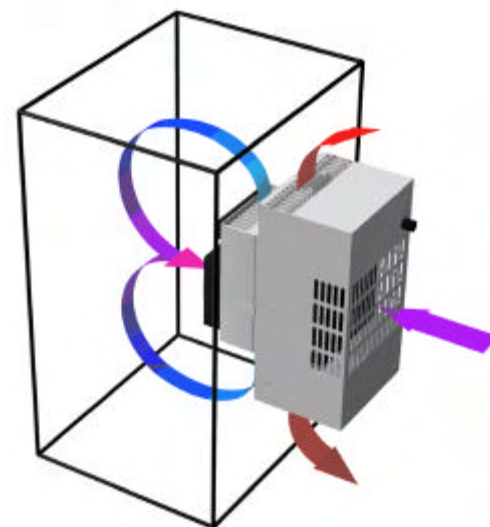

DIMENSIONS

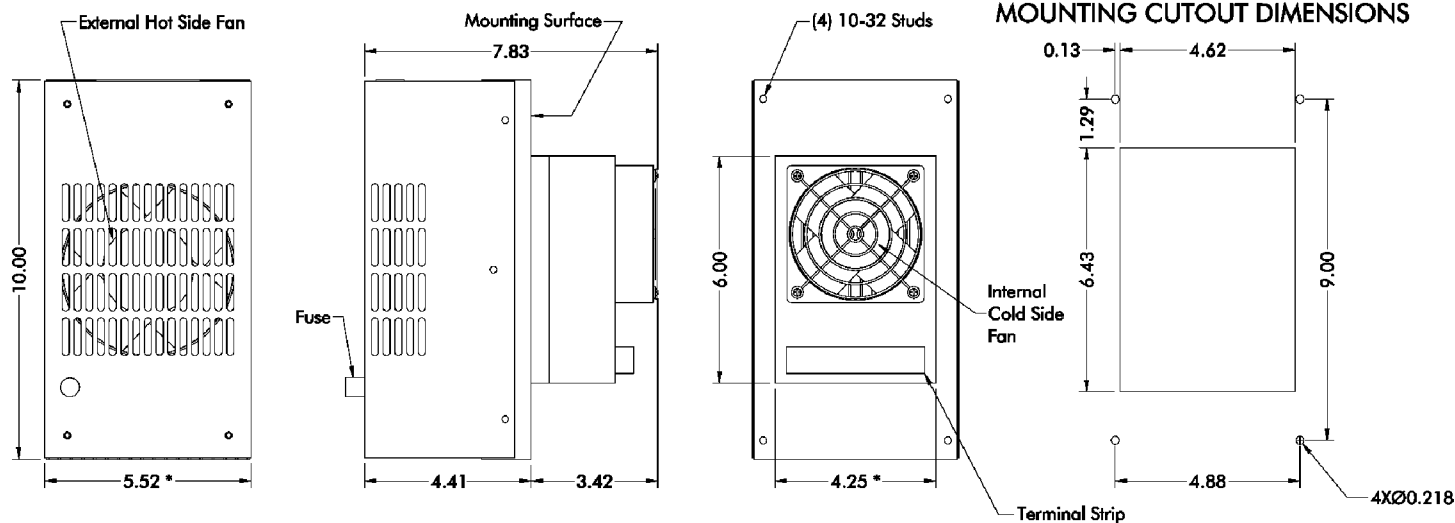

* Dimension does not include hardware, insulation. Dimensions: Inches, Mounting hardware and gasket included but not shown.

LTR	DESCRIPTION	DATE	APPROVED
-----	-------------	------	----------

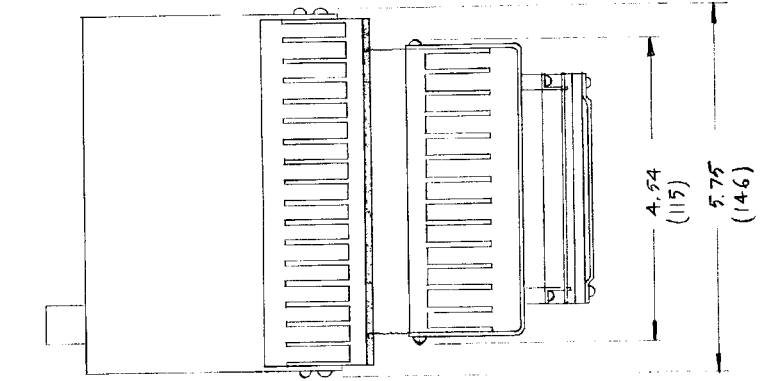

DIMENSIONS : INCHES
(MILLIMETERS)

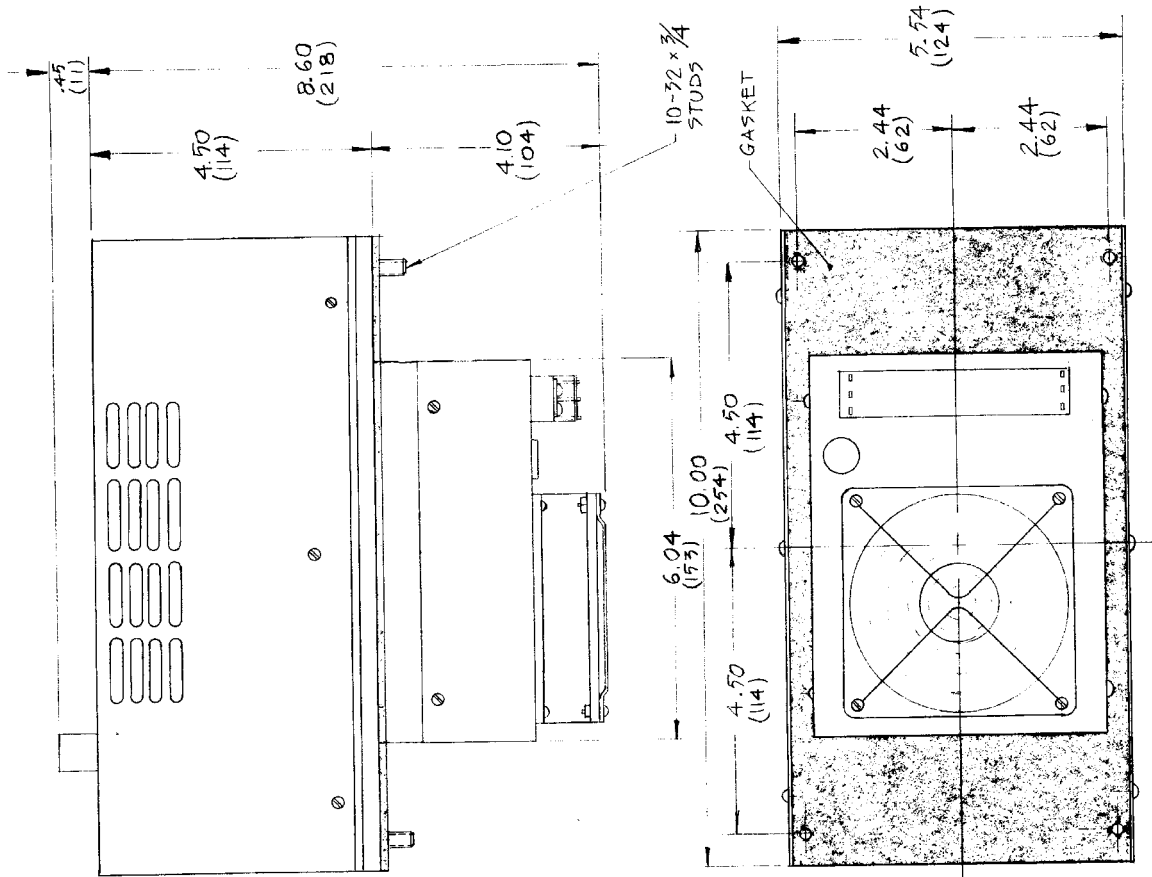

		ThermoElectric Cooling America Corp.	
UNLESS OTHERWISE SPECIFIED DIMENSIONS ARE IN INCHES TOLERANCES ARE: FRACTIONS DECIMALS ANGLES .XX ± .XXX ±		AHP 301 FF ASSEMBLY	
MATERIAL		SIZE	DRAWING NO.
FINISH		B	301-B-A51
APPROVALS	DATE	SCALE	SHEET
IN.	02.02.90	1/2	DOCS1
CHECKED			OF

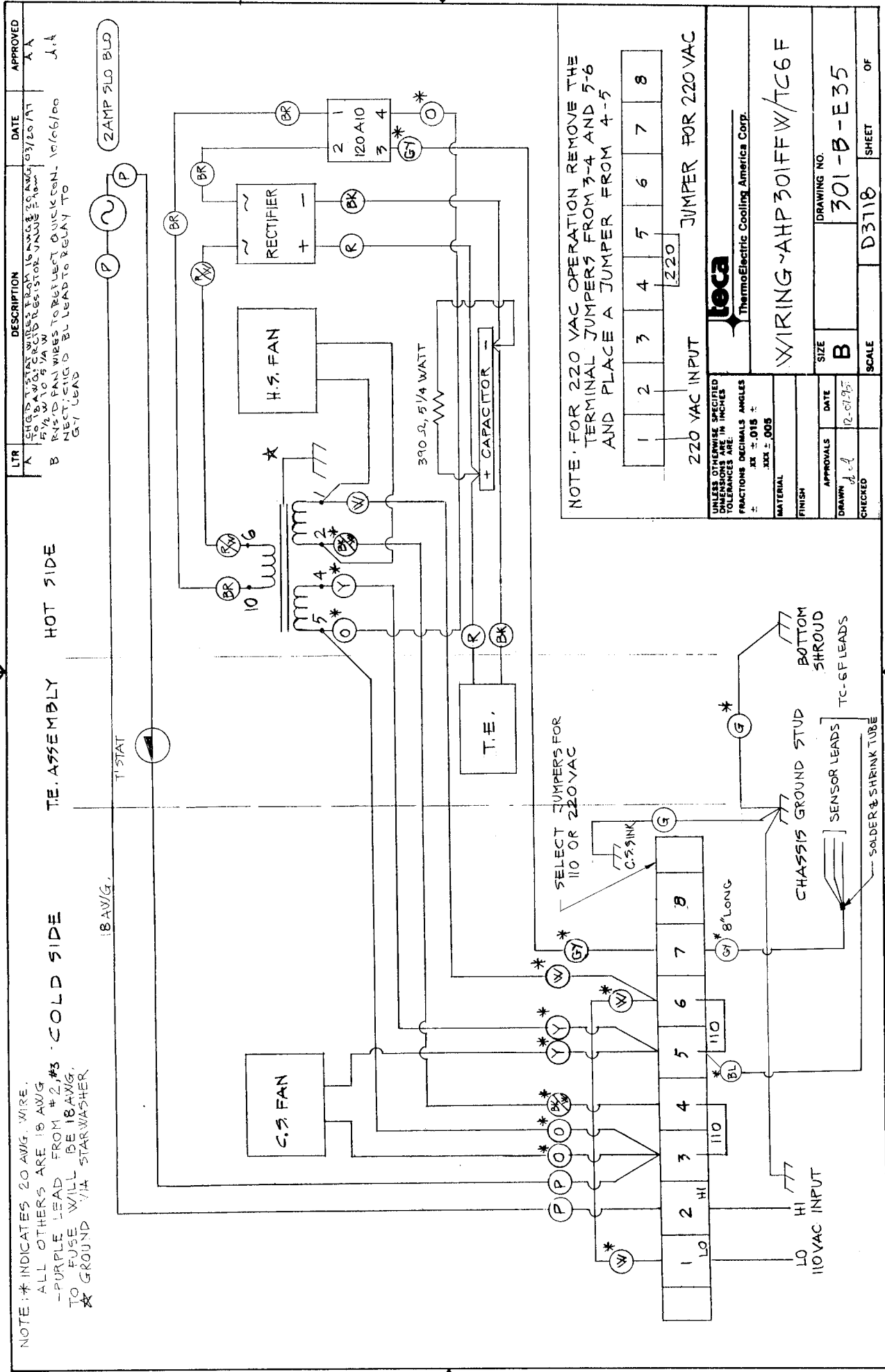

NOTE: * INDICATES 20 AWG. WIRE.
 ALL OTHERS ARE 18 AWG.
 -PURPLE LEAD FROM #2, #3 TO FUSE WILL BE 18 AWG.
 * GROUND VIA STARWASHER.

LTR	DESCRIPTION	DATE	APPROVED
A	CHG. 2 AMP FUSE FROM 10 AWG TO 18 AWG. 03/20/71	03/20/71	A.A.
B	CHG. 2 AMP FUSE FROM 10 AWG TO 18 AWG. 03/20/71 REVD FAN WIRE TO REFLECT QUICK CON. 10/6/6100 REVD FAN WIRE TO REFLECT QUICK CON. 10/6/6100 REVD FAN WIRE TO REFLECT QUICK CON. 10/6/6100 REVD FAN WIRE TO REFLECT QUICK CON. 10/6/6100 REVD FAN WIRE TO REFLECT QUICK CON. 10/6/6100		J.14

NOTE: FOR 220 VAC OPERATION REMOVE THE TERMINAL JUMPERS FROM 3-4 AND 5-6 AND PLACE A JUMPER FROM 4-5

1	2	3	4	5	6	7	8
220				JUMPER FOR 220 VAC			

UNLESS OTHERWISE SPECIFIED DIMENSIONS ARE IN INCHES TOLERANCES ARE:	
XX ± .015	+
.XXX ± .005	+
MATERIAL	
FINISH	
APPROVALS	DATE
DRAWN J.14	12-01-95
CHECKED	

 ThermoElectric Cooling America Corp.	
WIRING AHP301FFW/TC6F	
SIZE	DRAWING NO.
B	301-B-E35
SCALE	SHEET
D3718	OF

SELECT JUMPERS FOR 110 OR 220 VAC

C.S. SINK

CHASSIS GROUND STUD

SENSOR LEADS

TC-6F LEADS

SOLDER & SHRINK TUBE

BOTTOM SHROUD

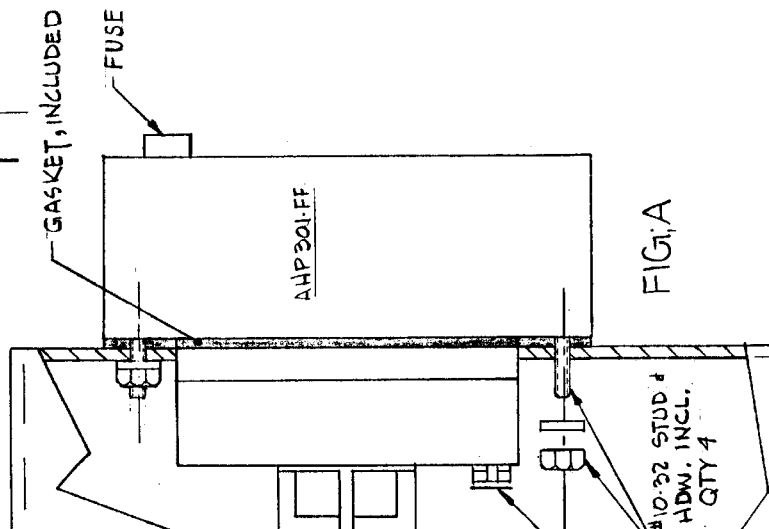

FIG. A

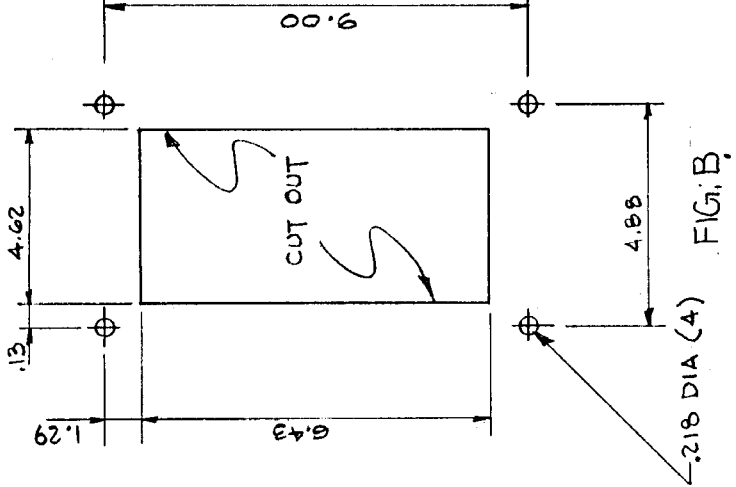

FIG. B

MOUNTING HOLES AND CUTOUT

MOUNTING INSTRUCTIONS

- DETERMINE DESIRED MOUNTING LOCATION. INTERNAL CLEARANCE REQUIRED IS 4.0 DEEP X 4.75" WIDE X 6.00 LONG FOR THE PORTION OF THE UNIT THAT EXTENDS INTO THE ENCLOSURE.
- A RECTANGULAR CUTOUT SURROUNDED BY CLEARANCE HOLES FOR THE MOUNTING STUDS IS REQUIRED IN THE ENCLOSURE WALL. SEE FIG B, MOUNTING HOLES AND CUTOUT FOR DIMENSIONS.
- MOUNT UNIT USING HARDWARE PROVIDED. GASKET SHOULD BE IN PLACE BETWEEN HEATSINK AND ENCLOSURE WALL SO THAT POSITIVE SEAL RESULTS. SEE FIG A,

TERMINAL STRIP FOR 115 OR 230 VOLTS AC INPUT POWER

UNLESS OTHERWISE SPECIFIED DIMENSIONS ARE IN INCHES TOLERANCES ARE:
 FRACTIONS DECIMALS ANGLES
 ± .XX ± .015 ±
 .XXX ± .005

MATERIAL: _____
 FINISH: _____

APPROVALS: _____ DATE: 10.27.89
 DRAWN I.N.
 CHECKED: _____

ThermoElectric Cooling America Corp.	
FIELD MOUNTING AHP301-FF	
SIZE: B	DRAWING NO: AHP-301-B-FI
SCALE: D0367	SHEET: OF

Control/Thermostats

The model **TC-6F** (Cool Only) thermostat is designed using two magnetic reed switches in conjunction with a solid state relay. A three position switch is provided to adjust between the following settings:

Position	Control Temp.	Tolerance	Reset Differential
1	35°C	+/-5°C	10°C Maximum
2	25°C	+/-5°C	10°C Maximum
3	Constant On		

The model **TC-3F** (Heat/Cool) thermostat incorporates the same technology as the TC-6F. It contains a single setting each for both heating and cooling as referenced below:

Mode	Control Temp.	Tolerance	Reset Differential
Cooling	35°C	+/-5°C	-10°C Maximum
Heating	15 °C	+/-5°C	+10°C Maximum

LIMITED WARRANTY

In the event a defect in material or workmanship is discovered in any of TECA's products within one year after the date they are delivered to Buyer, and if: (a) TECA is notified of the defect in writing by certified mail within 14 days of the date of discovery; (b) TECA may then either, at its sole discretion, inspect the product at Buyer's location, or require that the product be made available at Buyer's expense at TECA's premises for TECA's inspection within 14 days of the date of notification; and (c) the products are defective and the defects result from faulty materials and/or workmanship and not in any way from accident, misuse, misapplication, mishandling, modification, or alteration by the Buyer or the shipper, then TECA shall, at its sole option, repair or exchange defective products free of charge to Buyer, or credit to buyer the price of the defective products. ALL OTHER WARRANTIES, EXPRESS OR IMPLIED, ARE EXCLUDED, INCLUDING BUT NOT LIMITED TO THE IMPLIED WARRANTIES OF MERCHANTABILITY AND FITNESS FOR A PARTICULAR PURPOSE. IN NO EVENT SHALL TECA BE LIABLE FOR ANY CLAIM BASED UPON BREACH OF EXPRESS OR IMPLIED WARRANTY OR ANY OTHER DAMAGES WHETHER SPECIAL, INDIRECT, INCIDENTAL, CONSEQUENTIAL, LOST PROFITS, BUSINESS INTERRUPTION, OR LOSS OF BUSINESS OR CUSTOMER RELATIONSHIPS.

RETURNED GOODS, RESTOCKING CHARGES

In order to return merchandise for any reason (repair, replacement, or credit) a return authorization number must be issued by TECA. New merchandise may not be returned for credit beyond 60 days from shipment. Charges for incidental or other damages may also be made. All returned goods must be sent freight prepaid. A restocking charge of 15% will apply. On special equipment and custom modified equipment orders, additional incremental cancellation charges may be made.